

# STAINLESS STEEL SERIES

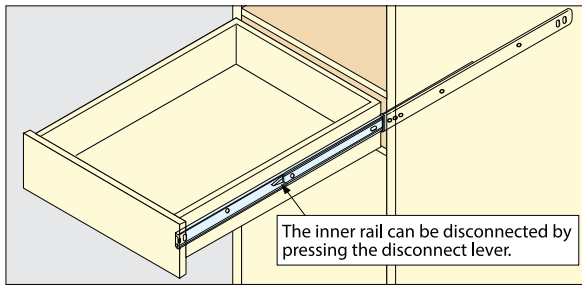

**SUGATSUNE**



ESR-4513 & ESR-3813

## SPECIFICATIONS AT A GLANCE

- Load capacities ranging from 55 ~ 599lbs
- Maximum travel lengths of 732mm
- Mount with M4 or #8 Binding, Pan or Truss Head screws
- 304 Stainless Steel, RoHs Compliant

### 3/4 Extension

### Full Extension

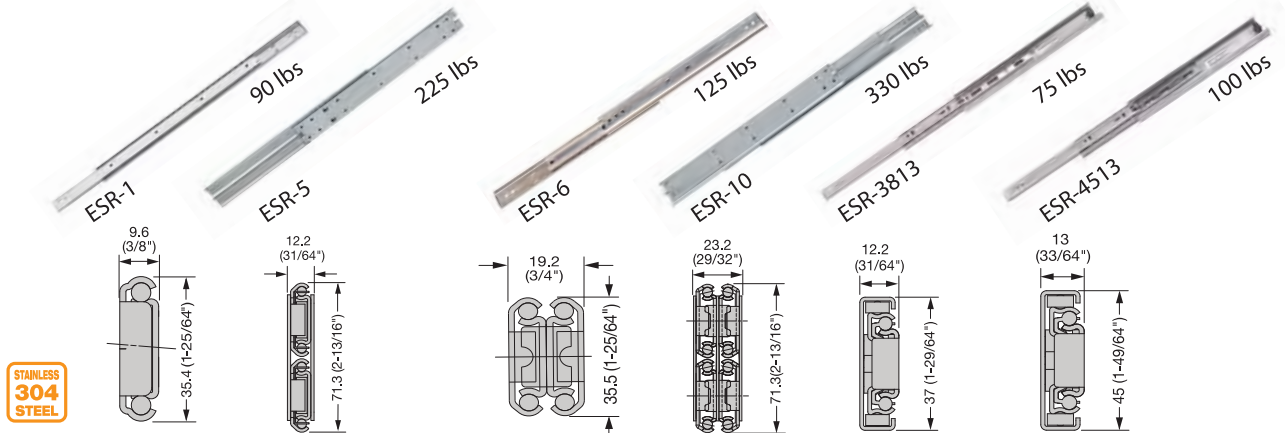

Non-Handed	✓	✓	✓	✓	✓	✓
Positive Stop		✓	✓	✓	✓	✓
Front Disconnect	✓				✓	✓
Friction Break Stop	✓					
Hold-In Detent					✓	✓





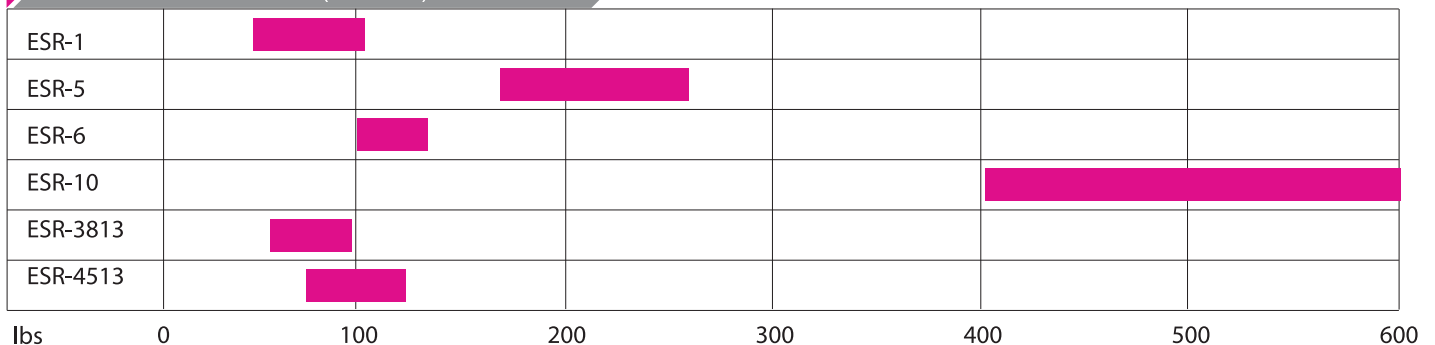

### Drawer Slide Terms

- Positive Stop ----- Drawer stops at extended/open position, but does not lock or detent.
- Friction Brake Stop -- Drawer stops at extended/open position by the resistance of the ball retainer. Usually achieved by deforming the slide races to achieve an interference fit.
- Hold-in Detent ----- Drawer is firmly held in the fully closed position and is released by pulling outward. This feature is also known as a Positive Catch.
- Front Disconnect --- Drawer member can be disconnected by actuating the disconnect lever.

### MAXIMUM LOAD RATING (PER PAIR)



## CONCEALED HINGES

Image	Item Number	Mounting Plates
 <p><b>STAINLESS 304 STEEL</b> *19mm OVERLAY</p>	304B-46/19 Free Swinging	
	304B-C46/19 Self-Closing	304B-P3A
 <p><b>STAINLESS 304 STEEL</b> *14mm OVERLAY</p>	304B-46/14 Free Swinging	
	304B-C46/14 Self-Closing	304B-P4A/32
 <p><b>STAINLESS 304 STEEL</b> *9mm OVERLAY</p>	304B-46/9 Free Swinging	
	304B-C46/9 Self-Closing	304B-P4A/32-3W

**STAINLESS 304 STEEL** All Mounting Plates are sold separately

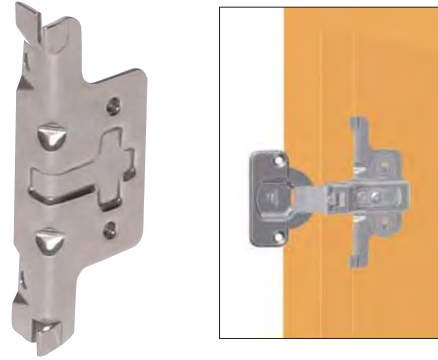

**STAINLESS 304 STEEL**

Face Frame Bracket for 304B-P4A/32 and 304B-P4A/32-3W. (Sold separately)

Material	Finish
304 Stainless Steel	Polished

## 304B Series Stainless Steel Hinges

- Please be sure to confirm door weight in advance, and be sure that the door weight is centered
- Hinges should be installed within 4" of the top and bottom edges of the door. If using 3 or more hinges, please refer to the installation guide (to the right)
- Please lubricate after installation and on a regular basis from then on
- Please install at least 300 mm (12") apart

Maximum Door Specifications	
Width	Thickness
17-3/4" (450 mm)	3/4" (20 mm)

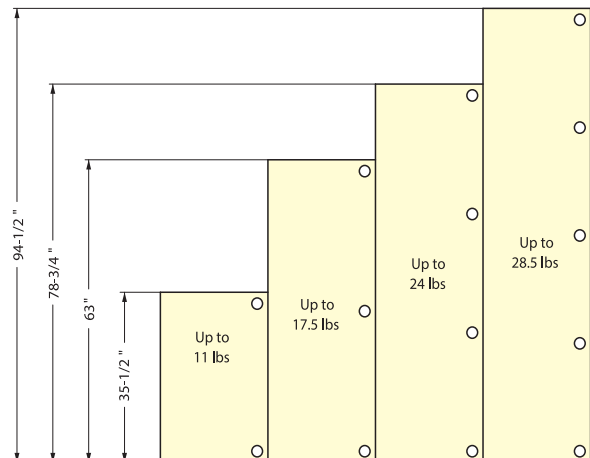

## LIFT-OFF HINGES

Lift-off hinges come left and right handed and are also available in weld-on versions.



## GLASS HINGES

Our glass hinges are available for half overlay or inset.



## QUICK RELEASE HINGES

Our hinges allow for easy installation and removal of doors.



## SPRING HINGES

Spring hinges are designed to close or open with spring tension. The spring hinges can be mounted any way and depending on installation, can keep lids open or closed.





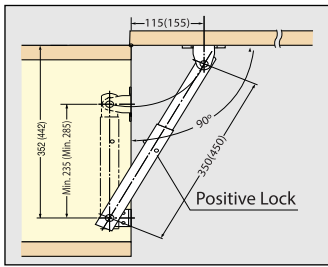

**HEAVY DUTY LID STAY**

**LB-S**

- Heavy duty lid stay holds lid or panel in fully opened position
- Lift up the lid panel to release the lid stay
- Can be installed individually or in pairs
- Non-Handed: Can be installed on the left or right side

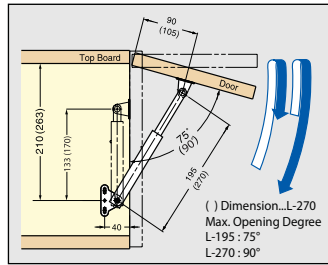

**LID STAY**

**L-195, 270**

- Holds lid or panel in fully opened position
- Lift up the lid panel to release the lid stay
- Can be installed individually or in pairs
- Non-Handed: Can be installed on the left or right side

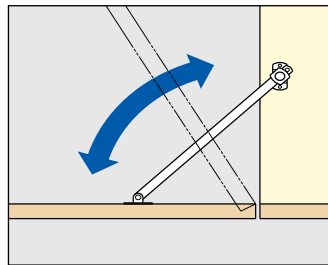

**LID STAY**

**HS**

- For downward-opening flap doors
- Can be installed individually or in pairs
- Non-Handed: Can be installed on the left or right side

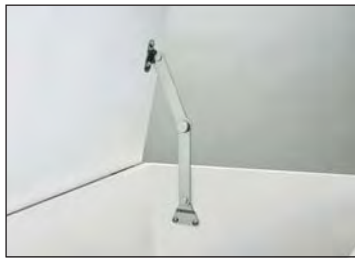
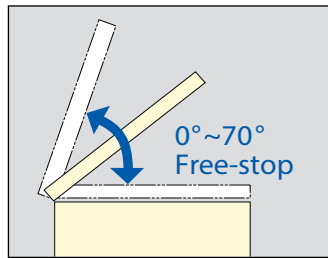

**TORQUE LID STAY**

**S-100T30**

- Friction torque lid stay holds lid open at any position
- Handed - Specific left and right hand mounting
- Can be used individually or in pairs
- 30.6 kg·cm ± 20% (26.5 lbs·in±20%)

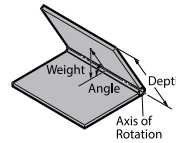

$$\text{panel weight (in pounds)} \times \text{panel depth (in inches)} \times \frac{1}{2} = \text{torque (in lbs·in)}$$

**MAXIMUM LOAD CAPACITY**

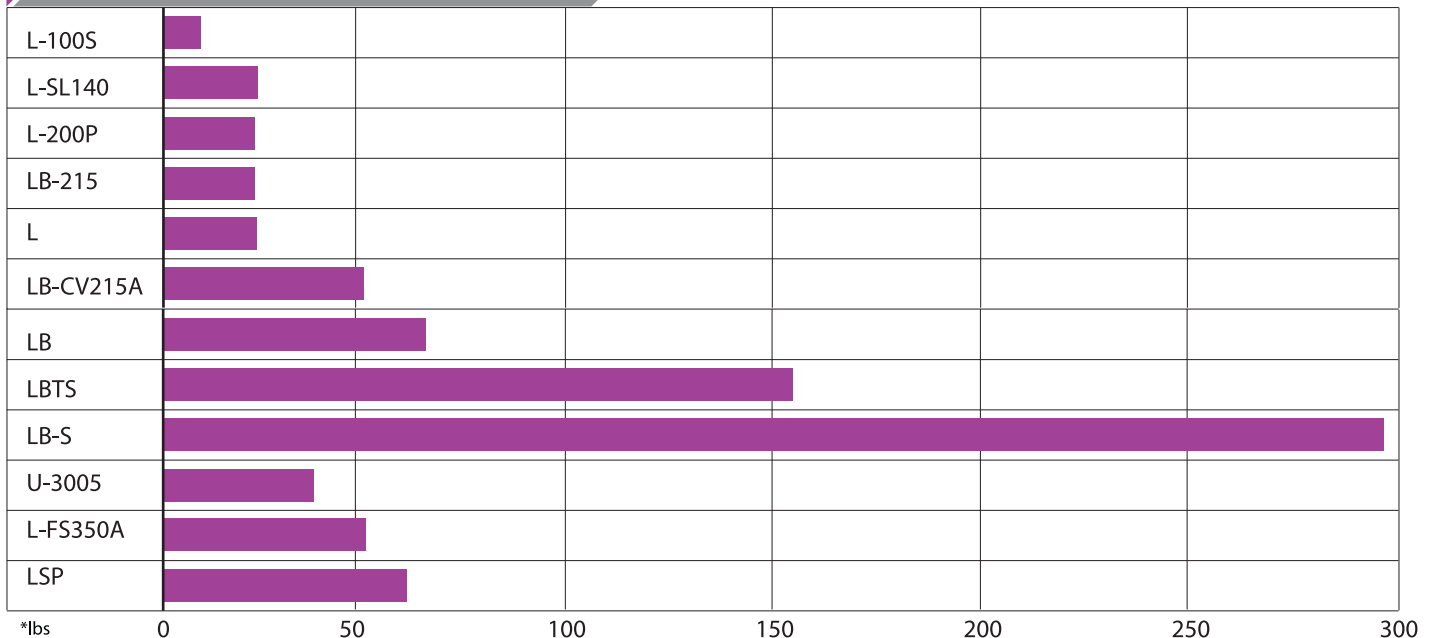

SEALED MAGNETIC CATCH			
Image	Item No.	Magnetic Force	Line Drawing
	MC-JM45WT	3 kg (6.6 lbs)	
	MC-JM63G-15	1.5 kg (3.3 lbs)	
	MC-JM63G-30	3 kg (6.6 lbs)	
	MC-JM63G-50	5 kg (11 lbs)	
	MC-JM50		
COUNTER PLATE	MC-JM49		

**MC-JM45WT / MC-JM63G / MC-JM50**

- Hermetically sealed, ideal for high corrosion resistance
- No metal-to-metal contact, ideal for clean room application
- Strong magnetic force
- Optional counterplate:
  - Stainless Steel-MC-JM49, AS-68
  - Plastic Sealed-MC-JMP45

Part Name	Material	Finish/Color
Body	Polypropylene	White
Magnet	Neodymium	-

**MC-JM49**

- Special Plate for MC-JM magnetic catches
- Equivalent to 304 stainless steel ideal for applications where rust is an issue
- High Corrosion resistant

Material	Finish
Stainless Steel	Plain

CATCHES & LATCHES		
Image	Item Number	Line Drawing
<p>STAINLESS 304 STEEL</p> <p>STAINLESS 316 STEEL</p>	BCTS-40	
	BCTS-50	
	BCTS-70	
<p>STAINLESS 304 STEEL</p>	BL-40SS	
	BL-60SS	
<p>STAINLESS 304 STEEL</p>	KR-50	
<p>STAINLESS 316 STEEL</p>	HP-635	
	HP-645	
	HP-660	

- 316 stainless steel for high corrosion resistance
- Tension force is not adjustable

Item No.	Push in Force (kg)	Pulling Force (kg)	Weight (g)
BCTS-40	2.0 ( 4.4 lbs)	1.3 ( 2.9 lbs)	18
BCTS-50	2.3 ( 5.0 lbs)	1.8 ( 3.9 lbs)	30
BCTS-70	5.7 (12.5 lbs)	3.9 ( 8.5 lbs)	83

- Supplied with mortise and surface strike

Item No.	L	D	Weight (g)	Box (pcs)	Carton (pcs)
BL-40SS	(1-37/64")	11	36	30	450
BL-60SS	(2-23/64")	15	50		

- Supplied with mortise and surface strike

Material	Finish
304 Stainless Steel	Satin



- Available as both weld-on and screw-on

Item No.	L	W	H	Weight (g)
HP-635S	3-1/2"	1-1/2"	1-3/8"	130
HP-645S	4-1/2"			184
HP-660S	6"	2"		302





(Drawings shown for weld-on type)

# HOOKS

## UTILITY HOOKS





Image	Item No.	Load Capacity (kg)	Finish
	XL-CUF-110TT XL-CUF-170TT <b>STAINLESS 303 STEEL</b>	15-32 (33-70 lbs)	Mirror Satin Combination
	JF-50 JF-80 JF-120 <b>STAINLESS 303 STEEL</b>	12-22 (26-48 lbs)	Mirror
	JF-45 JF-70 JF-110 <b>STAINLESS 303 STEEL</b>	10-12 (22-26 lbs)	Mirror
	JFT-180 JFT-260 <b>STAINLESS 303 STEEL</b>	10-15 (22-33 lbs)	Mirror

## LATCH HOOKS

Image	Item No.	Load Capacity (kg)	Finish
	EN-R80 <b>STAINLESS 316 STEEL</b>	Hook: 20 (44 lbs) Arm: 10 (22 lbs)	Polished
	WH-1 WH-2 <b>STAINLESS 304 STEEL</b>	15 (33 lbs)	Plain
	EN-K-84 EN-K-120 <b>STAINLESS 316 STEEL</b>	Hook: 20 -60 (44-132 lbs) Arm: 10 (22 lbs)	Polished
	EN-R80-K <b>STAINLESS 316 STEEL</b>	Hook: 20 (44 lbs) Arm: 10 (22 lbs)	Polished

# HANDLES

## HANDLES

Image	Item No.	Finish
	EK-S Series <b>STAINLESS 316 STEEL</b>	Satin / Mirror
	US SERIES <b>STAINLESS 304 STEEL</b>	Satin / Mirror
	16 SERIES <b>STAINLESS 304 STEEL</b>	Satin
	FT-120, 150 <b>STAINLESS 304 STEEL</b>	Mirror



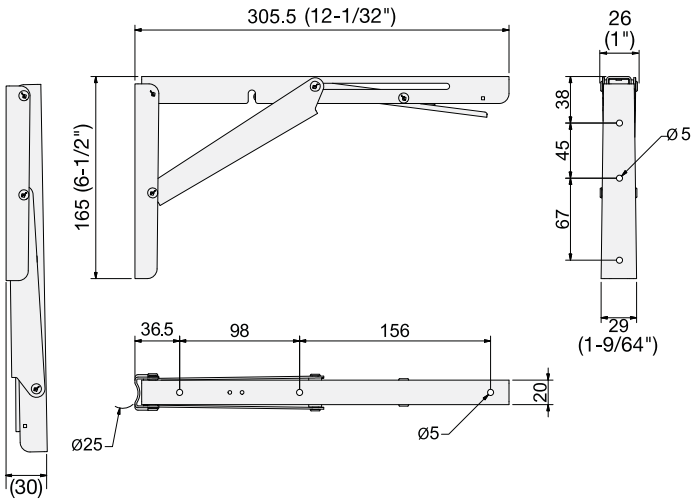



Item No.	EB-303/EP
Load Capacity (kg)	150 (330 lbs)/pc
Material	304 Stainless Steel

- Electro Polish finish
- Bracket and Hinge function in 1 unit
- Heavy duty load capacity

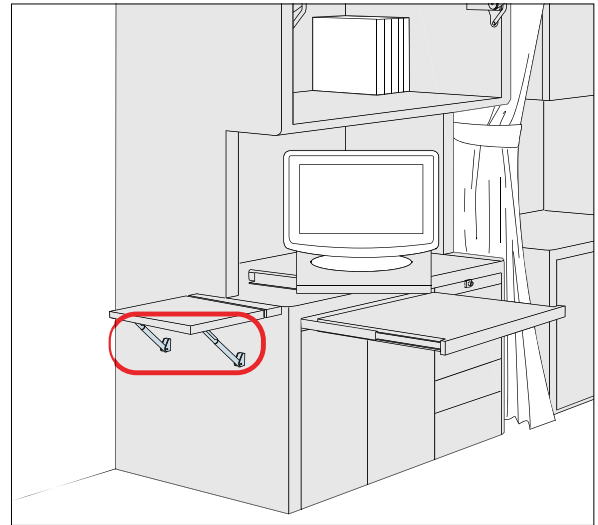
Our shelf support folding bracket locks when in open position and releases when lever is depressed.



**FOLDING BRACKETS**

Item No.	Load Capacity (kg)	Material
 EB-303/EP	150 (330 lbs)/pc	304 Stainless Steel
 GTS-300	3 (6.6 lbs)/pc	304 Stainless Steel

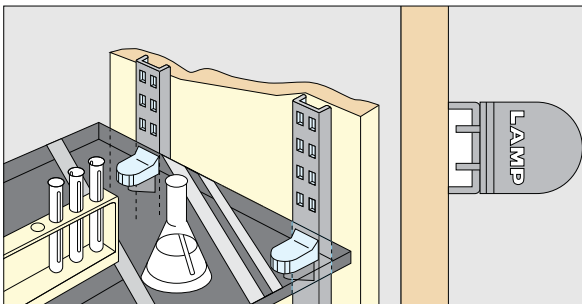

SPH-1820

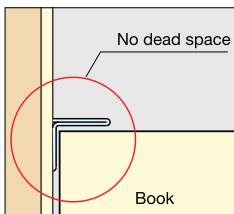



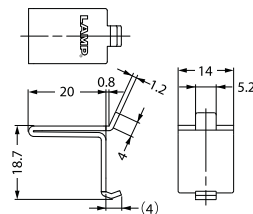

Installation SPF-20



304 stainless steel standards and supports allow for versatile designs and adjustability in any outdoor application

**SHELF STANDARDS**

Item No.	Load Capacity (kg)	Material
 SPH-1820		304 Stainless Steel
 SPH-15	40 (88 lbs)/ 4 pcs	304 Stainless Steel
 SP-1820		304 Stainless Steel
 SPF-20	45 (99 lbs)/ 4 pcs	304 Stainless Steel

Follow Us

 facebook.com/sugatsune

 twitter.com/sugatsune

 youtube.com/sugatsuneamerica

-  DOOR SYSTEMS
-  SOFT CLOSING MECHANISM
-  LID SUPPORTS
-  HINGES
-  HANDLES
-  SHELVING SYSTEM
-  SHELF STANDARD
-  HOOKS & BRACKETS
-  CLOSET HARDWARE
-  GLASS HARDWARE
-  CATCHES & LATCHES
-  DRAWER SLIDES
-  LEVELING GLIDES
-  CASTERS
-  MILLION LOCK SERIES
-  BATHROOM ACCESSORIES
-  MOTION DESIGNTEC

**SUGATSUNE** **LAMP**<sup>®</sup>

[www.sugatsune.com](http://www.sugatsune.com)

**Sugatsune America, Inc.**

**Head Office:**

18101 Savarona Way  
Carson, CA 90746

Phone: 310.329.6373  
Toll Free: 800.562.5267 (U.S.A. only)  
Fax: 310.329.0819  
E-mail: [sales@sugatsune.com](mailto:sales@sugatsune.com)

**Chicago Showroom / Sales Office:**

850 South Wabash Avenue #300  
Chicago, IL 60605

Phone: 312.461.1081  
Fax: 312.461.1082  
E-mail: [chicagoshowroom@sugatsune.com](mailto:chicagoshowroom@sugatsune.com)